



## MOUNTING INSTRUCTIONS



8kg (17.6lbs) max.



13" - 32" (33-81cm).

VESA75/100

## WARNING STATEMENTS

### Warning

Desktop structure must be capable of supporting at least a maximum weight 20 kg (44lbs). If not, the desktop must be reinforced. Proper installation procedure by a qualified service technician, as outlined in the installation instructions, must be adhered to. Failure to do so could result in serious personal injury, or even death.

Safety measures must be practiced at all times during the installation of this product. Use proper safety gear and tools for the installation procedure to prevent personal injury.

Prior to the installation of this product, the installation instructions should be read and completely understood. The installation instructions must be read to prevent personal injury and property damage. Keep these installation instructions in an easily accessible location for future reference.

 Do not install on a structure that is prone to vibration, movement or chance of impact. Failure to do so could result in damage to the display and/or damage to the mounting surface.







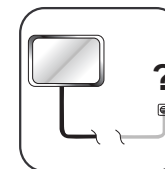
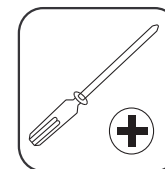

 Do not install near heater, fireplace, direct sunlight, air conditioning or any other source of direct heat energy. Failure to do so may result in damage to the display and could increase the risk of fire.

 At least two qualified people should perform the installation procedure. Injury and/or damage can result from dropping or mishandling the display.

## TOOLS REQUIRED NOT INCLUDED



## PARTS INCLUDED

A	B
 (x4)  (x4)  (x4)	 (x4)  (x1)
C	D
 (x1)  (x1)	 (x3)  (x1)

E

F

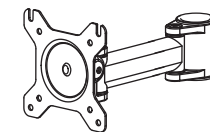

G

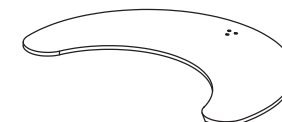

# ▶ INSTALLATION

①

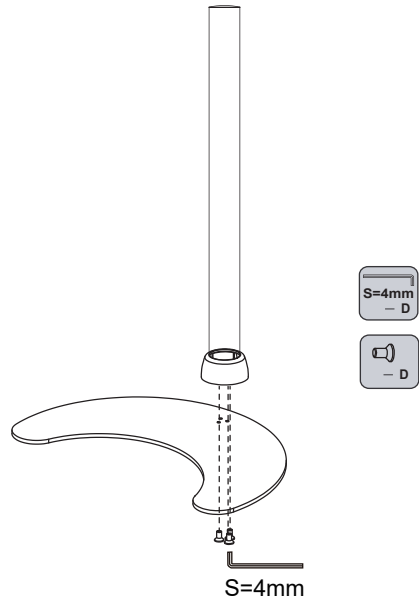

③

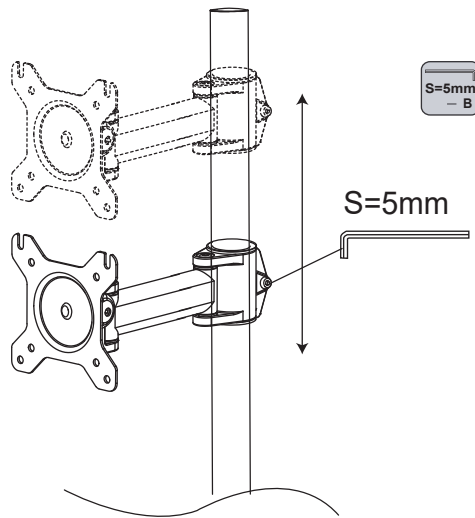

OR 4

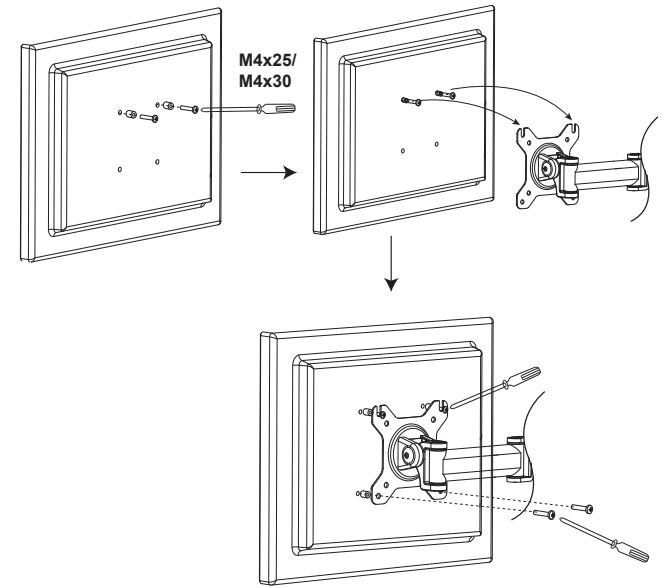
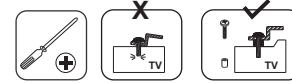

②

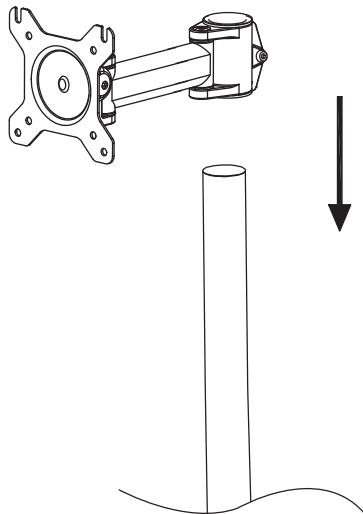

④

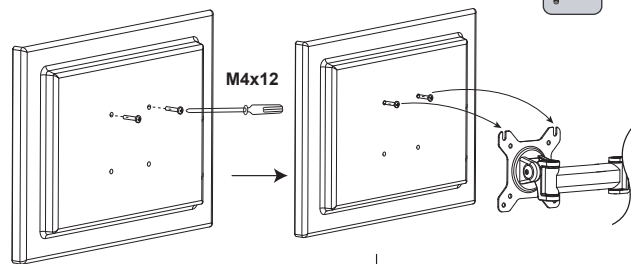
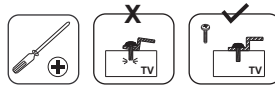

⑤

